

COD.	D	d	d1	H
033.0001	10	5.5	6.5	4
033.0002	12	5.5	6.5	4

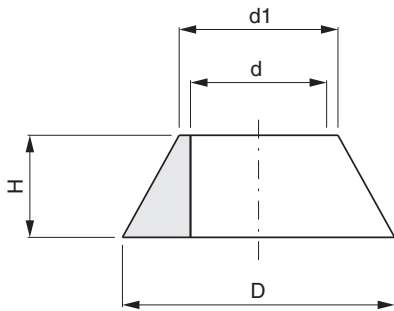

COD.	D	d	d1	H
033.0300	11	6	7	3.5
033.0302	12	6	7	4.5
033.0303	12	7	8	4
033.0305	12	6	8	3.5
033.0301	16	5.5	6.5	6.3
033.0304	17	5	6	4

033.0306

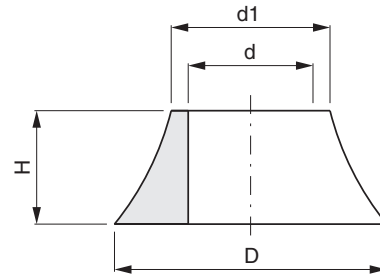
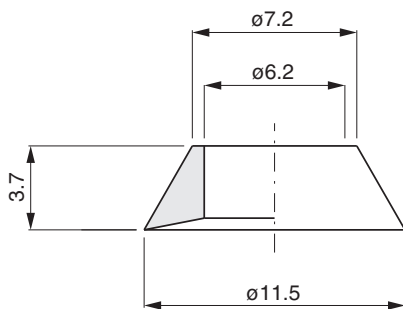

COD.	D	d	d1	H
033.0126	11	5	6.5	5
033.0100	11	5	7	4
033.0101	11	6	7	4.5
033.0102	11	5.5	6.5	4
033.0125	11	5.8	7	4
033.0123	11.5	5.7	6	5
033.0121	11.5	7	8	4
033.0124	11.5	7	8	4
033.0103	12	7.5	8.5	4
033.0104	12	6	7	4.5
033.0105	12	5.5	7	5
033.0106	12	8	9	3.5
033.0122	12	7	8	4.5
033.0107	13	5.5	6.5	4
033.0108	13	6	8	4
033.0109	13	6.7	7.5	4
033.0127	13	7.5	9	3.5
033.0110	14	6	7	4
033.0111	15	6	7	4
033.0112	16	6	7	4
033.0113	17	6	7	4
033.0114	17	6.5	7.5	6
033.0115	18	6.5	7.5	4
033.0116	19	6.5	7.5	4
033.0117	19.5	5.5	6.5	4
033.0118	20	6.5	7.5	6
033.0119	21	6.5	7.5	6
033.0120	22	5.5	6.5	6
033.0128	10.75	5.1	6.5	4.1

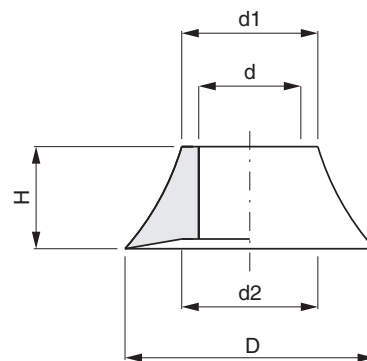

COD.	D	d	d1	d2	H
033.0500	11	4.5	6	6	4.5
033.0501	11	4.7	6	8	5
033.0503	11.4	5	6.6	5	5
033.0504	11.5	5	7	7.5	4.8



DEFLETTORI

SPREADERS

DEFLECTEURS

SCHIRMMANSCHETTEN

DISPERSORES

033.0502

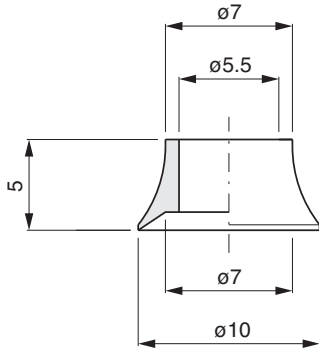

033.0600

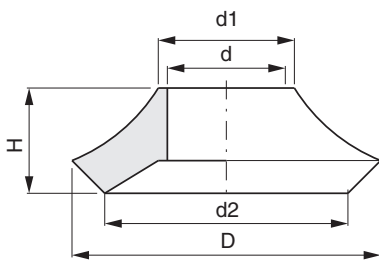
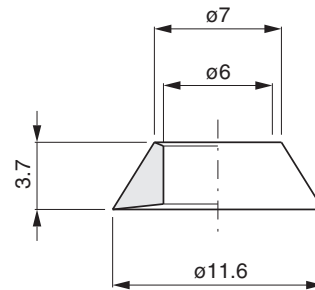

COD.	D	d	d1	d2	H
033.0700	11.8	5	7	10.5	5
033.0703	14	6	7	12	5
033.0704	15	6	7	12.6	5
033.0705	16	6	7	14	5
033.0701	17	6	7.5	13.4	5.8
033.0707	17	9	10.5	14	5
033.0702	19	6	7.5	15.4	5.8
033.0706	19	9	10.5	16	5

033.0900

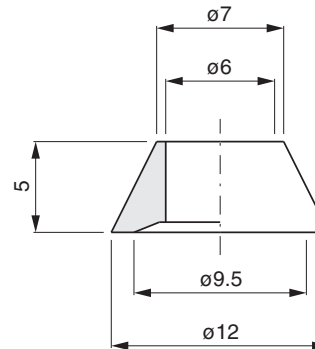

033.0901

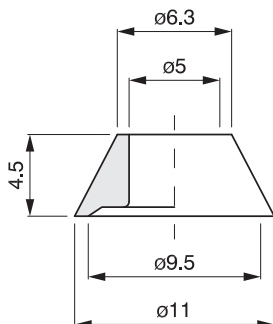

033.1100

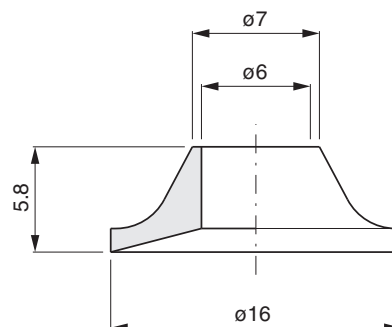

DEFLETTORI

SPREADERS

DEFLECTEURS

SCHIRMMANSCHETTEN

DISPERSORES

033.1101

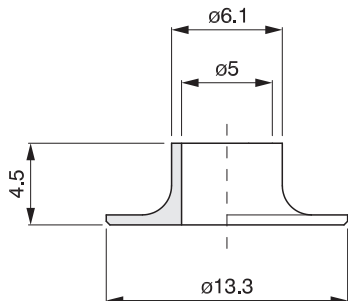

033.1102

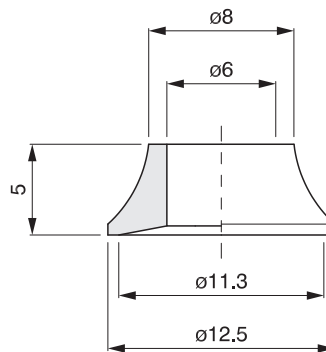

033.1301

