

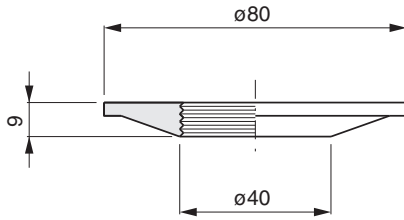

035.1500

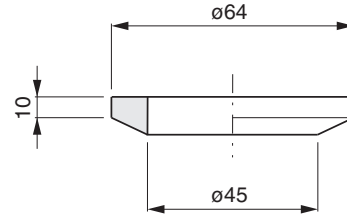

035.1501



035.1502

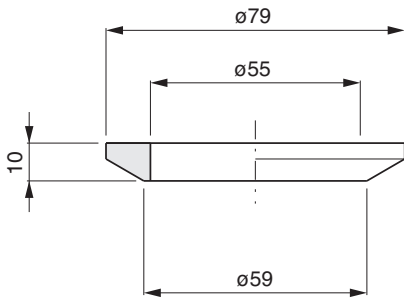

035.1503

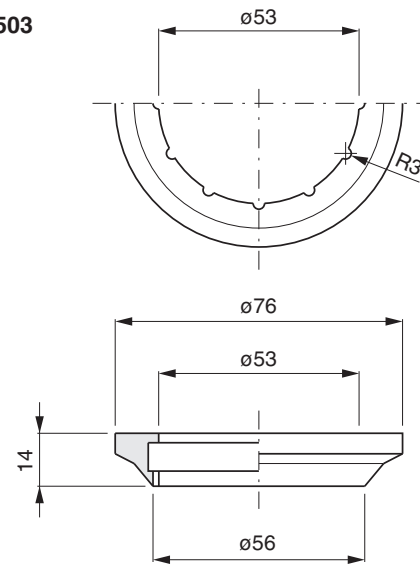

035.1504

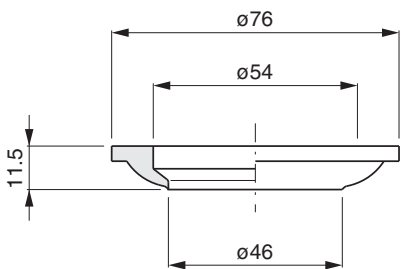

035.1505

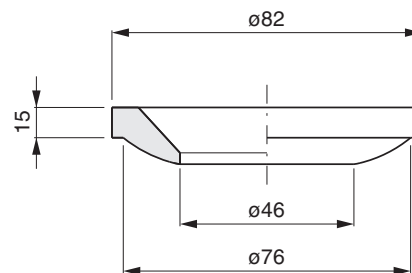

GUARNIZIONI IMBOCCATURA LATTINE

TIN CONVEYING SYSTEM SEALS
DOSEN-DICHTUNG

JOINTS POUR REMPLISSEUSES DE CANETTES
JUNTAS PARA EMBOCADURA LATAS

035.1506

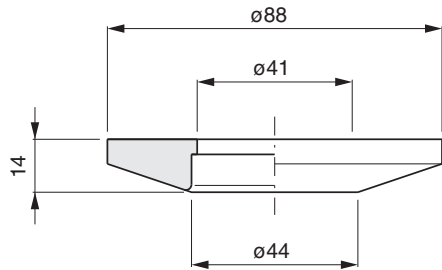

035.1507

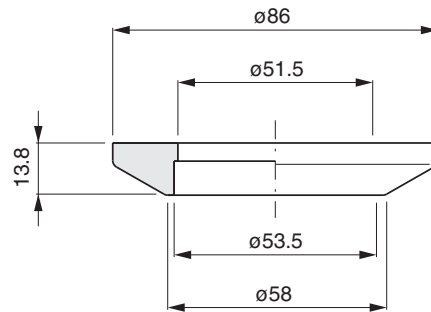

035.1508

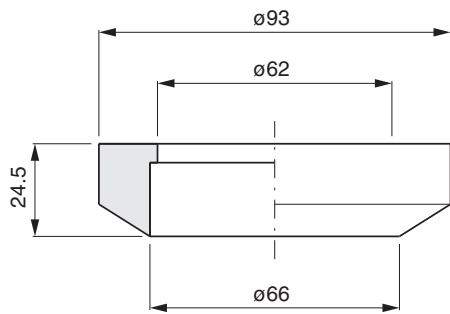

035.1509

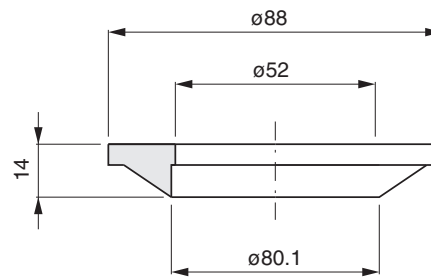

035.1510

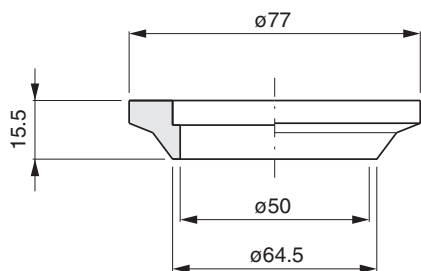

035.1511

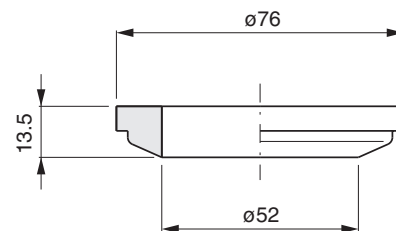

GUARNIZIONI IMBOCCATURA LATTINE

TIN CONVEYING SYSTEM SEALS
DOSEN-DICHTUNG

JOINTS POUR REMPLISSEUSES DE CANETTES
JUNTAS PARA EMBOCADURA LATAS

035.1512

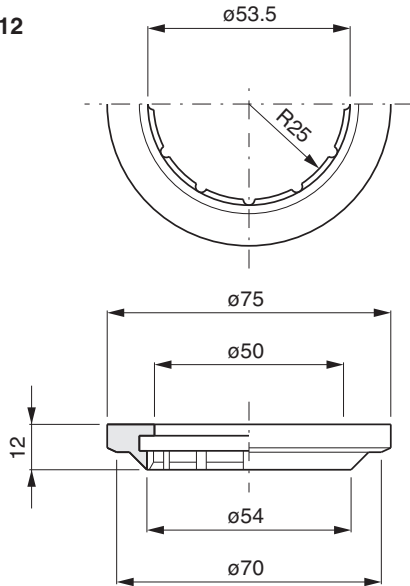

035.1514

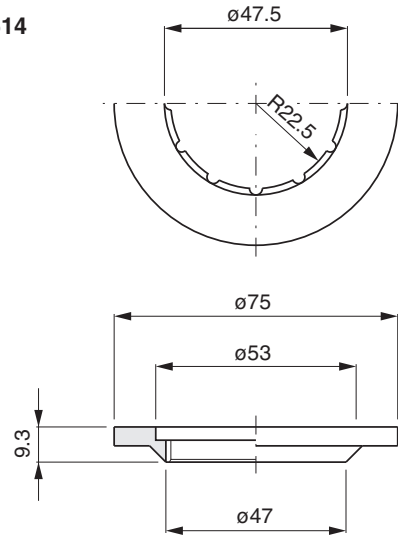

035.1515

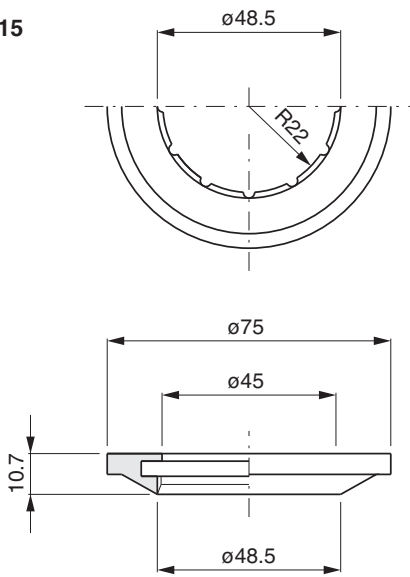

035.1516

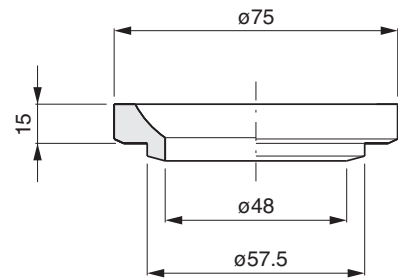

035.1517

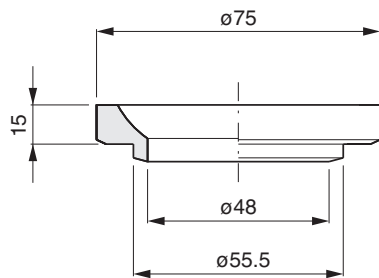

035.1518

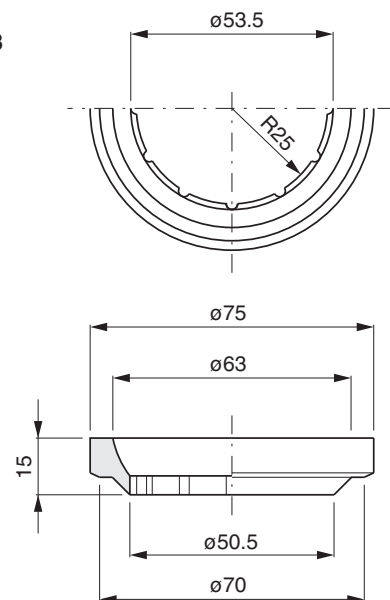

GUARNIZIONI IMBOCCATURA LATTINE

TIN CONVEYING SYSTEM SEALS
DOSEN-DICHTUNG

JOINTS POUR REMPLISSEUSES DE CANETTES
JUNTAS PARA EMBOCADURA LATAS

035.1519

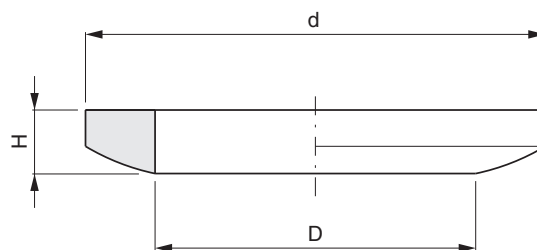
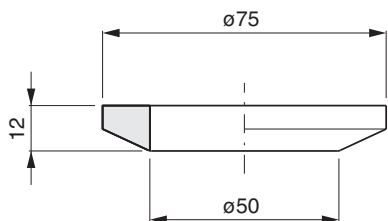

COD.	D	d	H
035.1520	76	53	10.5
035.1529	95	73	10.5

035.1521

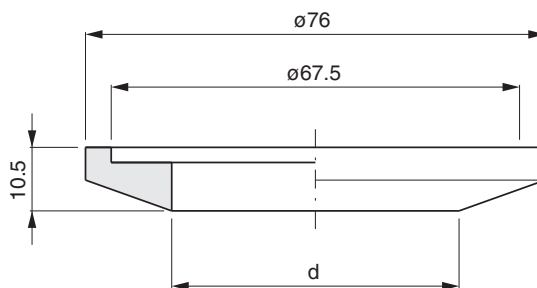
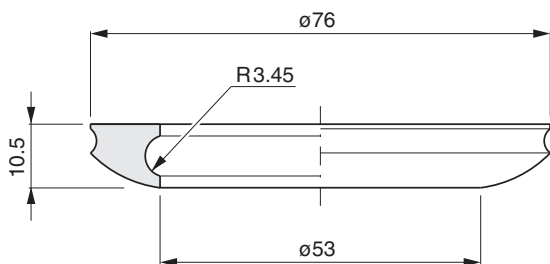

COD.	d
035.1522	47.5
035.1523	56.5

035.1524

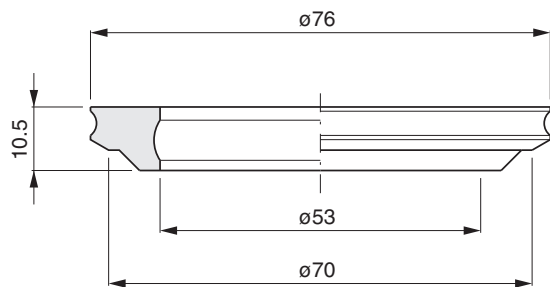

035.1525

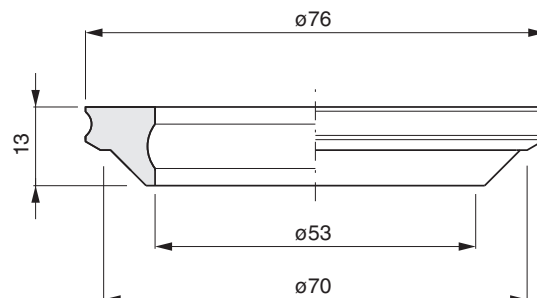

GUARNIZIONI IMBOCCATURA LATTINE

TIN CONVEYING SYSTEM SEALS
DOSEN-DICHTUNG

JOINTS POUR REMPLISSEUSES DE CANETTES
JUNTAS PARA EMBOCADURA LATAS

035.1526

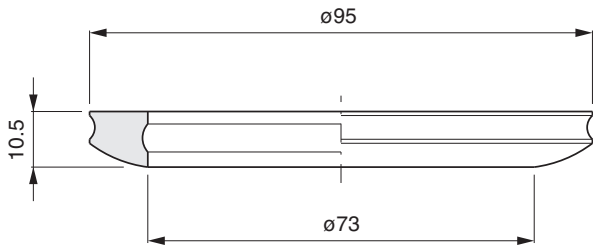

035.1527

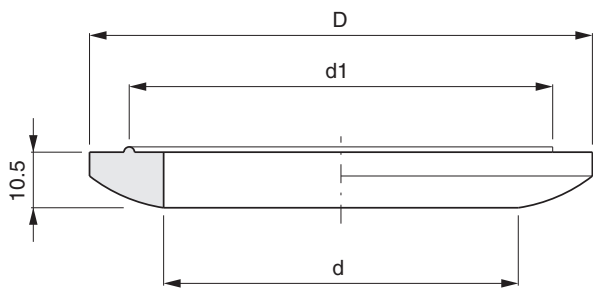
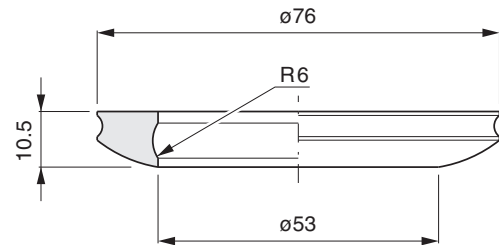

COD.	D	d	d1
035.1531	76	45	65
035.1532	76	53	65
035.1528	95	67	80
035.1530	95	58	76

035.1533

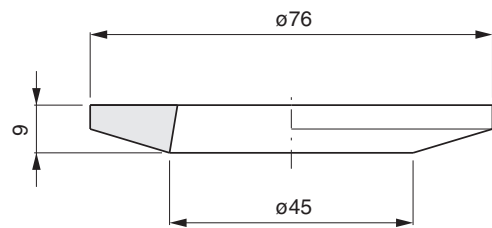

035.1534

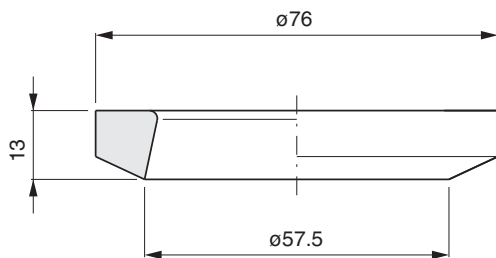

035.1535

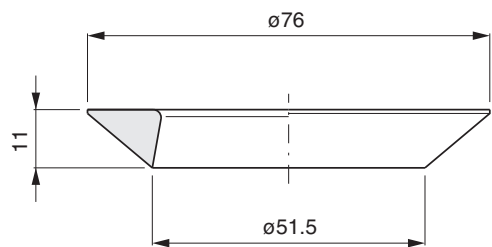

GUARNIZIONI IMBOCCATURA LATTINE

TIN CONVEYING SYSTEM SEALS
DOSEN-DICHTUNG

JOINTS POUR REMPLISSEUSES DE CANETTES
JUNTAS PARA EMBOCADURA LATAS

035.1536

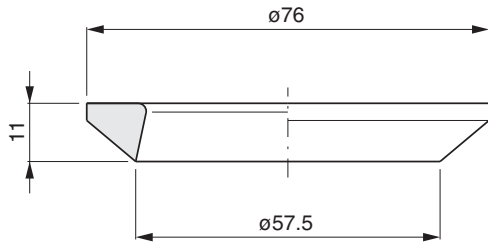

035.1537

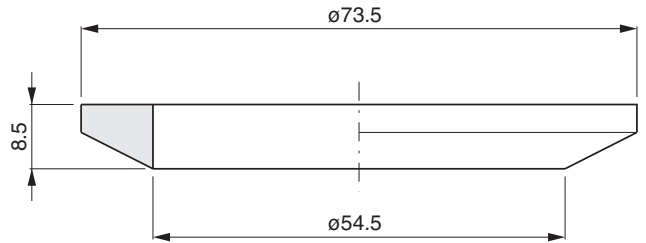

035.1538

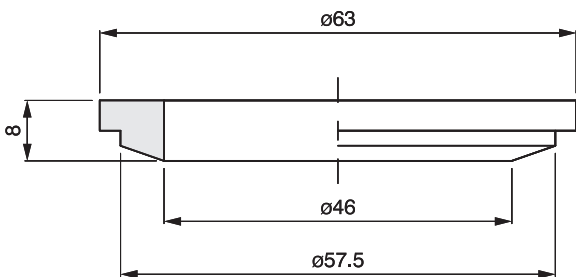

035.1549

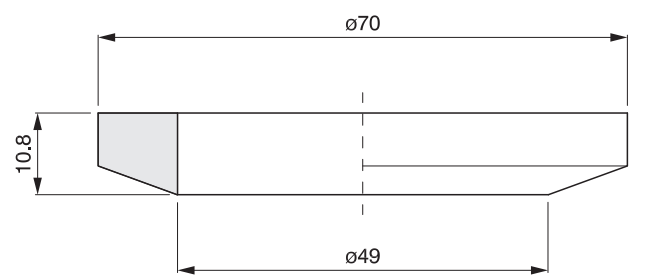

035.1553

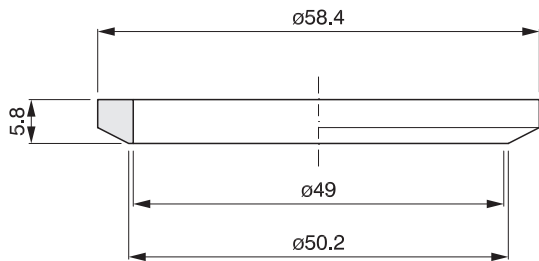

035.1561

